

POT. 8,5 - 20,0 kW ⚡ 7,0 - 16,8 kW

H17

SHAPE MAIOLICA

silent
BRUSHLESS TECHNOLOGY

perfect **connect**
OPTIMIZE COMBUSTION EVERYWHERE AND EVERYWHEN



 kg 254

 L x B x H
L x L x H
cm 54 x 57 x 123

☆☆☆☆
Four-star product

2022
ECO DESIGN

A++
A++

TECHNISCHE GEGEVENS OP PAGINA
DATOS TÉCNICOS EN PÁGINA
DONNÉES TECHNIQUES À LA PAGE

75



Pellet thermokachel met frontventilatie

*Termoestufa de pellets con ventilación frontal
Thermopoêle à granulés avec ventilation frontale*



Standaard afstandsbediening met kamerthermostaatfunctie
*Control remoto con función de termostato ambiente de serie
Télécommande avec fonction de thermostat d'ambiance en standard*



Wi-Fi module (standaard meegeleverd)
*Wi-Fi incluido
Module Wi-Fi de série*

Automatische buisbundelreiniging
*Limpeza automática del haz de tubos
Nettoyage automatique du faisceau de tubes*



White

Bordeaux

Hazelnut

Black

H17 V SHAPE

✂ cm 54 x 57 x 123

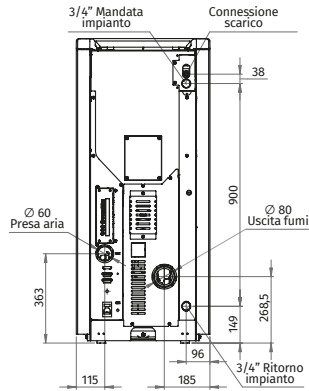
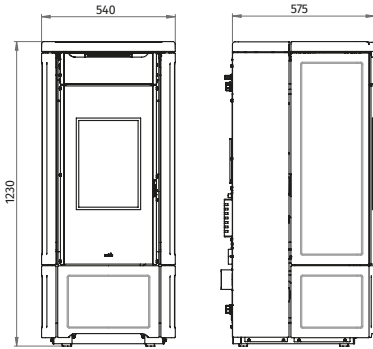

Nominale warmteafgifte Potencia tèrmica nominal Puissance thermique nom.	kW	min	8.1	max	18.6
Pelletverbruik Consumo de pellets Consommation granulés	kg/h	min	1.75	max	4.13
Rendement Rendimiento Rendement	%		92.2		
Tankinhoud Capacidad del tanque Capacité du réservoir	kg		21		
Rookgasafvoerbuīs Tubo de salida de humo Tuyau de sortie des fumées	Ø mm		80		
Branduren Autonomía Autonomie	h	min	5.1	max	12.0
Geïnstalleerd vermogen Potencia instalada Puissance électrique	W		20		
Netto gewicht Peso neto Poids net	kg		220		

H17 V SHAPE STEEL

✂ cm 54 x 57 x 123

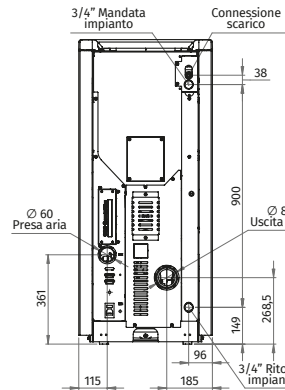
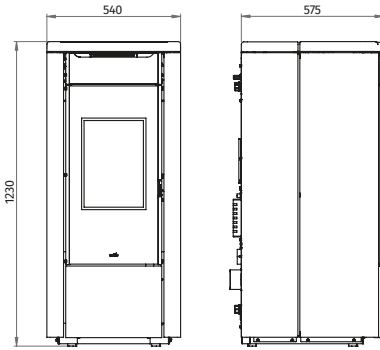

Nominale warmteafgifte Potencia tèrmica nominal Puissance thermique nom.	kW	min	8.1	max	18.6
Pelletverbruik Consumo de pellets Consommation granulés	kg/h	min	1.75	max	4.13
Rendement Rendimiento Rendement	%		92.2		
Tankinhoud Capacidad del tanque Capacité du réservoir	kg		21		
Rookgasafvoerbuīs Tubo de salida de humo Tuyau de sortie des fumées	Ø mm		80		
Branduren Autonomía Autonomie	h	min	5.1	max	12.0
Geïnstalleerd vermogen Potencia instalada Puissance électrique	W		20		
Netto gewicht Peso neto Poids net	kg		220		

H20 V SHAPE

✂ cm 57 x 66 x 130

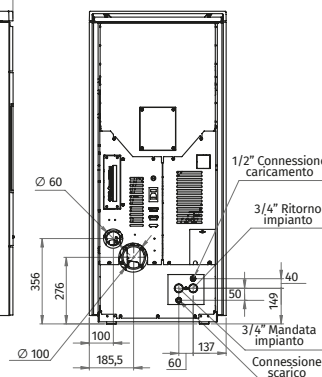
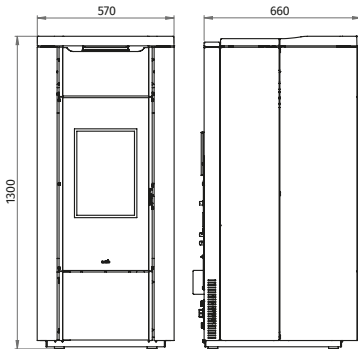

Nominale warmteafgifte Potencia tèrmica nominal Puissance thermique nom.	kW	min	10.2	max	22.2
Pelletverbruik Consumo de pellets Consommation granulés	kg/h	min	2.27	max	4.92
Rendement Rendimiento Rendement	%		93.6		
Tankinhoud Capacidad del tanque Capacité du réservoir	kg		37		
Rookgasafvoerbuīs Tubo de salida de humo Tuyau de sortie des fumées	Ø mm		100		
Branduren Autonomía Autonomie	h	min	7.5	max	16.3
Geïnstalleerd vermogen Potencia instalada Puissance électrique	W		32		
Netto gewicht Peso neto Poids net	kg		260		