

POT. 8.5 - 16.6 kW | 8.5 - 20.0 kW    🔌 7.0 - 14.0 kW | 7.0-16.8 kW

H14 | H17

## SHAPE STEEL

**silent**  
BRUSHLESS TECHNOLOGY

**perfect**  
OPTIMIZE COMBUSTION

**connect**  
EVERYWHERE AND EVERYWHEN



 kg 185

 L x B x H  
L x L x H  
cm 54 x 57 x 123

☆☆☆☆  
Four-star product

**2022**  
ECO  
DESIGN

**A++**  
A++

TECHNISCHE GEGEVENS OP PAGINA  
DATOS TÉCNICOS EN PÁGINA  
DONNÉES TECHNIQUES À LA PAGE

74



Pellet thermokachel met frontventilatie

*Termoestufa de pellets con ventilación frontal*  
*Thermopoêle à granulés avec ventilation frontale*



Standaard afstandsbediening met kamerthermostaatfunctie

*Control remoto con función de termostato ambiente de serie*  
*Télécommande avec fonction de thermostat d'ambiance en standard*



Wi-Fi module (standaard meegeleverd)

*Wi-Fi incluido / Module Wi-Fi de série*

Automatische buisbundelreiniging

*Limpieza automática del haz de tubos*  
*Nettoyage automatique du faisceau de tubes*



White

Bordeaux

Bronze

Anthracite

## H14 V SHAPE

✂ cm 54 x 57 x 123

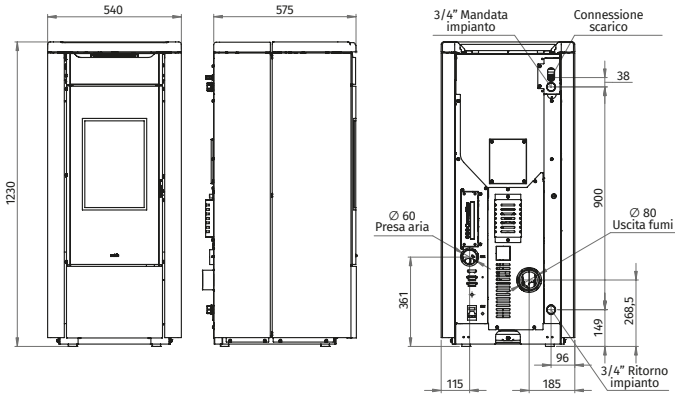

<b>Nominale warmteafgifte</b> Potencia tèrmica nominal Puissance thermique nom.	kW	min max	<b>8.1</b> <b>15.6</b>
<b>Pelletverbruik</b> Consumo de pellets Consumation granulés	kg/h	min max	<b>1.75</b> <b>3.4</b>
<b>Rendimento</b> Rendimento	%		<b>93.8</b>
<b>Tankinhoud</b> Capacidad del tanque Capacité du réservoir	kg		<b>21</b>
<b>Rookgasafvoerbuīs</b> Tubo de salida de humo Tuyau de sortie des fumées	Ø		<b>80</b>
<b>Branduren</b> Autonomia Autonomie	h	min max	<b>6.1</b> <b>12.0</b>
<b>Geïnstalleerd vermogen</b> Potencia instalada Puissance électrique	W		<b>20</b>
<b>Netto gewicht</b> Peso neto Poids net	kg		<b>185</b>

## H14 | H17 V SHAPE ROUND

✂ cm 53 x 61 x 125

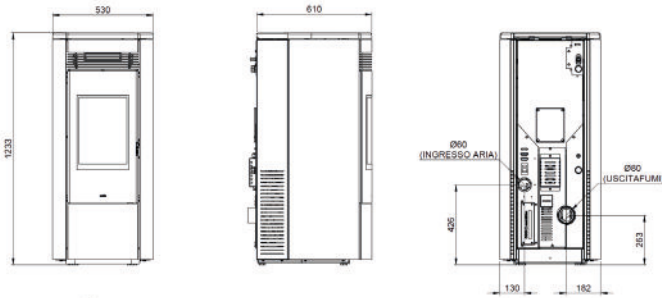

H14 H17

<b>Nominale warmteafgifte</b> Potencia tèrmica nominal Puissance thermique nom.	kW	min max	<b>8.1</b> <b>15.6</b>	<b>8.1</b> <b>18.6</b>
<b>Pelletverbruik</b> Consumo de pellets Consumation granulés	kg/h	min max	<b>1.75</b> <b>3.4</b>	<b>1.75</b> <b>4.13</b>
<b>Rendimento</b> Rendimento	%		<b>93.8</b>	<b>92.2</b>
<b>Tankinhoud</b> Capacidad del tanque Capacité du réservoir	kg		<b>21</b>	<b>21</b>
<b>Rookgasafvoerbuīs</b> Tubo de salida de humo Tuyau de sortie des fumées	Ø		<b>80</b>	<b>80</b>
<b>Branduren</b> Autonomia Autonomie	h	min max	<b>6.1</b> <b>12.0</b>	<b>5.1</b> <b>12.0</b>
<b>Geïnstalleerd vermogen</b> Potencia instalada Puissance électrique	W		<b>20</b>	<b>20</b>
<b>Netto gewicht</b> Peso neto Poids net	kg		<b>185</b>	<b>220</b>

## H17 V LIGHT

✂ cm 94 x 35 x 112

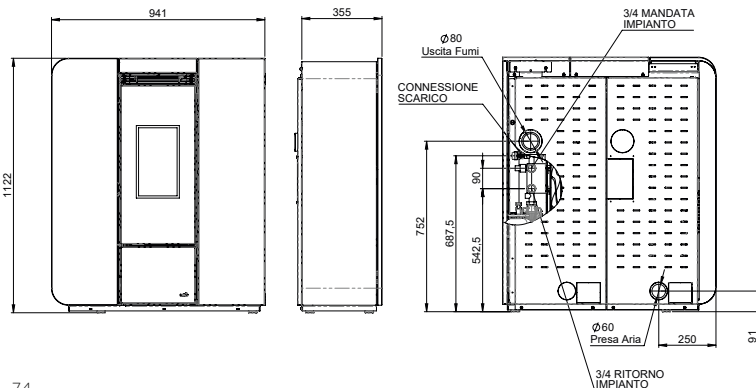

<b>Nominale warmteafgifte</b> Potencia tèrmica nominal Puissance thermique nom.	kW	min max	<b>7.9</b> <b>20.0</b>
<b>Pelletverbruik</b> Consumo de pellets Consumation granulés	kg/h	min max	<b>1.75</b> <b>4.42</b>
<b>Rendimento</b> Rendimento	%		<b>93.3</b>
<b>Tankinhoud</b> Capacidad del tanque Capacité du réservoir	kg		<b>25</b>
<b>Rookgasafvoerbuīs</b> Tubo de salida de humo Tuyau de sortie des fumées	Ø		<b>80</b>
<b>Branduren</b> Autonomia Autonomie	h	min max	<b>5.6</b> <b>14.4</b>
<b>Geïnstalleerd vermogen</b> Potencia instalada Puissance électrique	W		<b>23</b>
<b>Netto gewicht</b> Peso neto Poids net	kg		<b>210</b>

## H17 V SHAPE

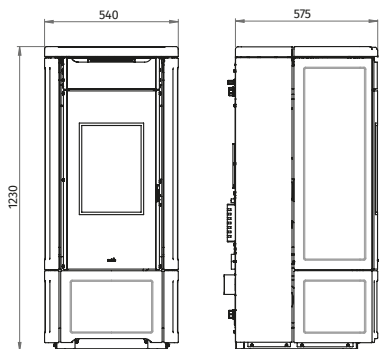

✂ cm 54 x 57 x 123

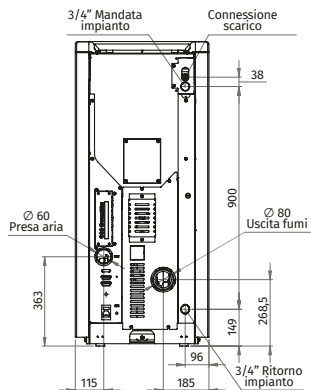

<b>Nominale warmteafgifte</b>	kW	min	8.1
Potencia tèrmica nominal	kW	max	18.6
Puissance thermique nom.	kW		
<b>Pelletverbruik</b>	kg/h	min	1.75
Consumo de pellets	kg/h	max	4.13
Consommation granulés	kg/h		
<b>Rendement</b>	%		92.2
Rendimiento	%		
Rendement	%		
<b>Tankinhoud</b>	kg		21
Capacidad del tanque	kg		
Capacité du réservoir	kg		
<b>Rookgasafvoerbuis</b>	Ø mm		80
Tubo de salida de humo	Ø mm		
Tuyau de sortie des fumées	Ø mm		
<b>Branduren</b>	h	min	5.1
Autonomía	h	max	12.0
Autonomie	h		
<b>Geïnstalleerd vermogen</b>	W		20
Potencia instalada	W		
Puissance électrique	W		
<b>Netto gewicht</b>	kg		220
Peso neto	kg		
Poids net	kg		

## H17 V SHAPE STEEL

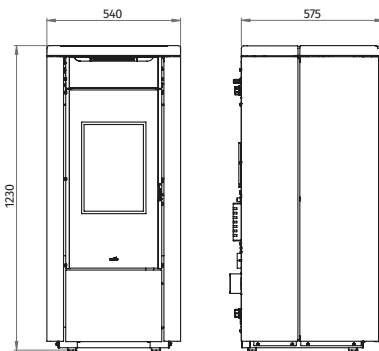

✂ cm 54 x 57 x 123

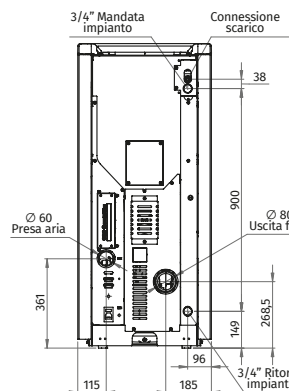

<b>Nominale warmteafgifte</b>	kW	min	8.1
Potencia tèrmica nominal	kW	max	18.6
Puissance thermique nom.	kW		
<b>Pelletverbruik</b>	kg/h	min	1.75
Consumo de pellets	kg/h	max	4.13
Consommation granulés	kg/h		
<b>Rendement</b>	%		92.2
Rendimiento	%		
Rendement	%		
<b>Tankinhoud</b>	kg		21
Capacidad del tanque	kg		
Capacité du réservoir	kg		
<b>Rookgasafvoerbuis</b>	Ø mm		80
Tubo de salida de humo	Ø mm		
Tuyau de sortie des fumées	Ø mm		
<b>Branduren</b>	h	min	5.1
Autonomía	h	max	12.0
Autonomie	h		
<b>Geïnstalleerd vermogen</b>	W		20
Potencia instalada	W		
Puissance électrique	W		
<b>Netto gewicht</b>	kg		220
Peso neto	kg		
Poids net	kg		

## H20 V SHAPE

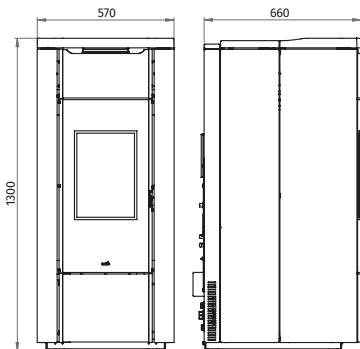

✂ cm 57 x 66 x 130

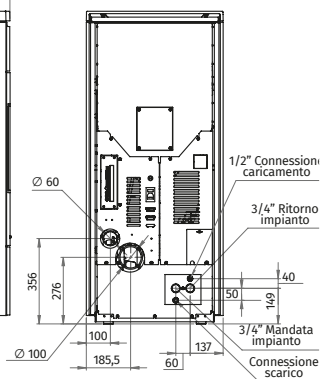

<b>Nominale warmteafgifte</b>	kW	min	10.2
Potencia tèrmica nominal	kW	max	22.2
Puissance thermique nom.	kW		
<b>Pelletverbruik</b>	kg/h	min	2.27
Consumo de pellets	kg/h	max	4.92
Consommation granulés	kg/h		
<b>Rendement</b>	%		93.6
Rendimiento	%		
Rendement	%		
<b>Tankinhoud</b>	kg		37
Capacidad del tanque	kg		
Capacité du réservoir	kg		
<b>Rookgasafvoerbuis</b>	Ø mm		100
Tubo de salida de humo	Ø mm		
Tuyau de sortie des fumées	Ø mm		
<b>Branduren</b>	h	min	7.5
Autonomía	h	max	16.3
Autonomie	h		
<b>Geïnstalleerd vermogen</b>	W		32
Potencia instalada	W		
Puissance électrique	W		
<b>Netto gewicht</b>	kg		260
Peso neto	kg		
Poids net	kg		