

POT. 4,9 - 11,0 kW | 4,9 - 12,9 kW

A11 | A13 ZENITH

silent
BRUSHLESS TECHNOLOGY

timeless
LONG-LASTING MATERIALS

perfect
OPTIMIZE COMBUSTION

connect
EVERYWHERE AND EVERYWHEN



 kg 176 V/C

 L x B x H
L x L x H
cm 52 x 54 x 121

☆☆☆☆☆
Five-star product

2022
ECO
DESIGN

A+
A+

TECHNISCHE GEGEVENS OP PAGINA
DATOS TÉCNICOS EN PÁGINA
DONNÉES TECHNIQUES À LA PAGE

71



Pellethaard met natuurlijke
convectie en frontventilatie
*Estufa de pellet con convección
natural y ventilación superior
Poêle à granulés avec convection
naturelle et ventilation frontale*



Standaard afstandsbediening met
kamerthermostaatfunctie
*Control remoto con función de
termostato ambiente de serie
Télécommande avec fonction de
thermostat d'ambiance en standard*



Pellethaard met natuurlijke
convectie, dubbele kanalisatie
achter * en frontventilatie
*Estufa de pellets con convección
natural, canalización doble en la parte
trasera* y ventilación frontal
Poêle à granulés avec convection
naturelle, conduit double* à l'arrière
et ventilation frontale*



Wi-Fi module (standaard
meegeleverd)
*Wi-Fi incluido / Module Wi-Fi
optionnel*



White



Bordeaux



Bronze



Anthracite

* Optionele kit / Kit opcional / Kit en option

A11 | A13 ROUND GLASS TOP cm 53 x 57 x 125

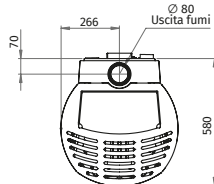
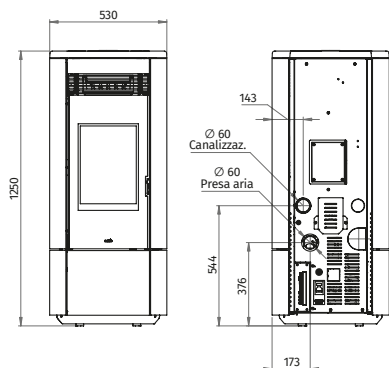

A11 A13
V C V C

Nominale warmteafgifte			
Potencia tèrmica nominal	kW	min	4.7 4.7
Puissance thermique nom.		max	10.2 12.1
Pelletverbruik			
Consumo de pellets	kg/h	min	1.05 1.05
Consommation granulés		max	2.90 2.75
Rendimento			
Rendimiento	%		91.5 91.3
Rendement			
Tankinhoud			
Capacidad del tanque	kg		17 17
Capacité du réservoir			
Rookgasafvoerbuīs			
Tubo de salida de humo	∅		80 80
Tuyau de sortie des fumées	mm		
Branduren			
Autonomia	h	min	7.4 6.2
Autonomie		max	16.2 16.2
Geïnstalleerd vermogen			
Potencia instalada	W		35 35
Puissance électrique			42 42
Netto gewicht			
Peso neto	kg		183 183
Poids net			

A11 | A13 ZENITH

 cm 52 x 54 x 121

A11 A13
V C V C

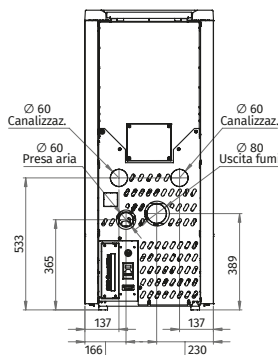

Nominale warmteafgifte			
Potencia tèrmica nominal	kW	min	4.7 4.7
Puissance thermique nom.		max	10.2 12.1
Pelletverbruik			
Consumo de pellets	kg/h	min	1.05 1.05
Consommation granulés		max	2.30 2.75
Rendimento			
Rendimiento	%		91.5 91.3
Rendement			
Tankinhoud			
Capacidad del tanque	kg		22 22
Capacité du réservoir			
Rookgasafvoerbuīs			
Tubo de salida de humo	∅		80 80
Tuyau de sortie des fumées	mm		
Branduren			
Autonomia	h	min	9.6 8.0
Autonomie		max	21.0 21.0
Geïnstalleerd vermogen			
Potencia instalada	W		35 35
Puissance électrique			50 50
Netto gewicht			
Peso neto	kg		183 183
Poids net			

A11 | A13 ZENITH PLUS

 cm 52 x 54 x 121

A11 A13
V C V C

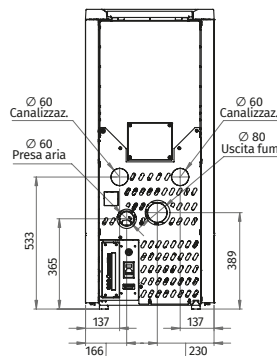
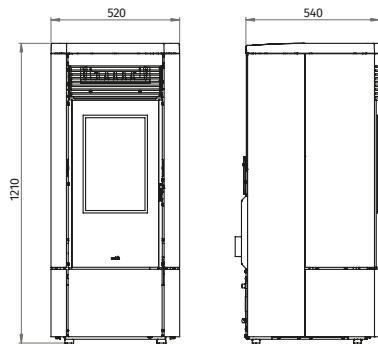

Nominale warmteafgifte			
Potencia tèrmica nominal	kW	min	4.7 4.7
Puissance thermique nom.		max	10.2 12.1
Pelletverbruik			
Consumo de pellets	kg/h	min	1.05 1.05
Consommation granulés		max	2.30 2.75
Rendimento			
Rendimiento	%		91.5 91.3
Rendement			
Tankinhoud			
Capacidad del tanque	kg		22 22
Capacité du réservoir			
Rookgasafvoerbuīs			
Tubo de salida de humo	∅		80 80
Tuyau de sortie des fumées	mm		
Branduren			
Autonomia	h	min	9.6 8.0
Autonomie		max	21.0 21.0
Geïnstalleerd vermogen			
Potencia instalada	W		35 35
Puissance électrique			50 50
Netto gewicht			
Peso neto	kg		183 183
Poids net			